



## Alfa Laval GJ BB

Save time and water with single-insertion barrel cleaning

### Application

The Alfa Laval GJ BB is part of the world-renowned Gamajet range of tank cleaning devices. With a single insertion of the Alfa Laval GJ BB, barrels and 208.2 l drums are cleaned in only 2-3 minutes while using only 30-45 l of water. This device offers high-performance cleaning combined with maximum durability. A heavy-duty stainless steel gear train remains outside the barrel or drum during cleaning, ensuring a long service life. The Alfa Laval GJ BB saves companies substantial amounts of time, water, and money.

### Working principle

The Gamajet range of high impact tank cleaning devices combine pressure and flow to create high impact cleaning jets. Cleaning occurs at the point at which the concentrated stream impacts the surface. It is this impact and the tangential force that radiates from that point which blasts contaminants from the surface, scouring the tank interior. In conjunction with this impact, the device is engineered to rotate in a precise, repeatable and reliable, 360° pattern. This full-coverage, global indexing pattern ensures the entire tank interior is cleaned, every time.



### TECHNICAL DATA

Lubricant . . . . . Food grade  
 Max. throw length . . . . . 2.5 m

#### Pressure

Working pressure . . . . . 5.5 - 83 bar  
 Recommended pressure . . . . . 5.5 - 55 bar

#### Cleaning Pattern

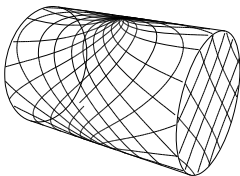

First Cycle

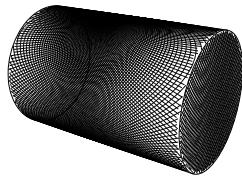

Full Pattern

The above drawings show the cleaning pattern achieved on a cylindrical horizontal vessel. The difference between the first cycle and the full pattern represents the number of additional cycles available to increase the density of the cleaning.

### PHYSICAL DATA

#### Materials

1.4404 (316L), PPS, PFTE, EPDM

#### Temperature

Max. working temperature . . . . . 95°C  
 Max. ambient temperature . . . . . 140°C

#### Weight

. . . . . 2.5 kg.

#### Connections

Standard thread . . . . . 3/8" NPT  
 Available option . . . . . 3/4" NPT, 3/4" BSP

#### Caution

Avoid hydraulic shock, hard and abrasive particles in the cleaning liquid, as this can cause increased wear and/or damage of internal mechanisms. In general, a filter in the supply line is recommended. Do not use for gas evacuation or air dispersion. For steaming we refer to the manual.

### Flow Rate

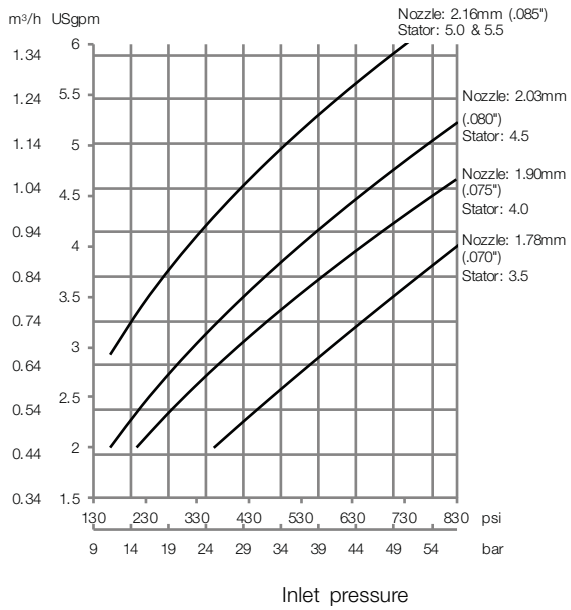

### Impact Throw Length

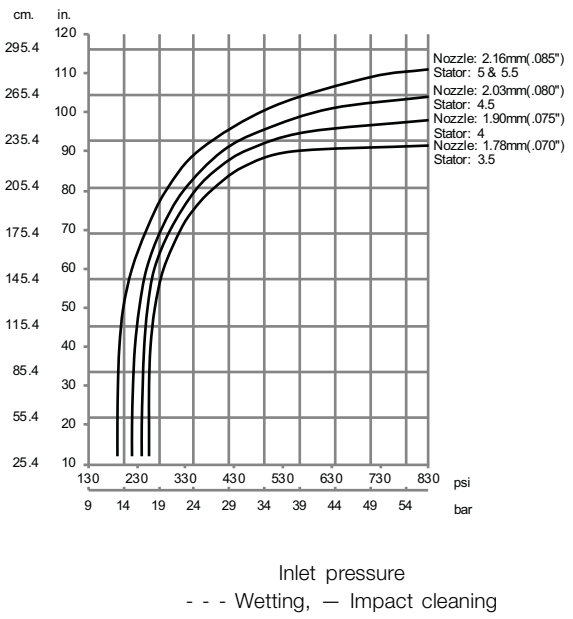

### Cleaning Time

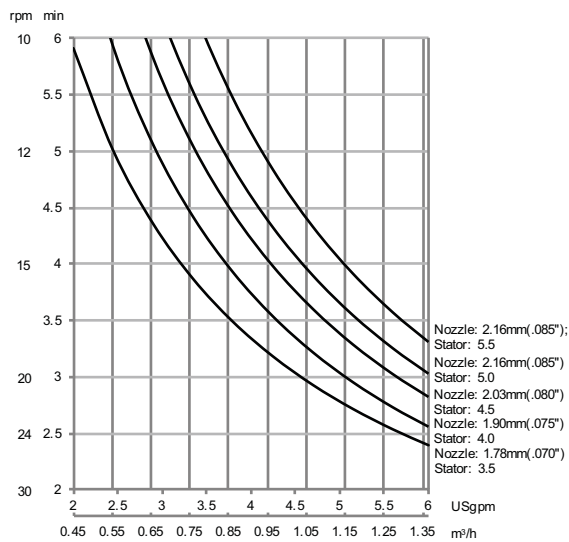

### Dimensions

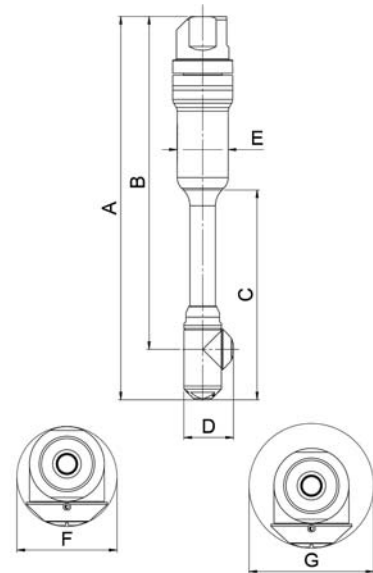

### Dimensions (mm)

|    | A   | B   | C   | D  | E  | F  | G  |
|----|-----|-----|-----|----|----|----|----|
| mm | 325 | 282 | 178 | 42 | 44 | 43 | 52 |

### Standard Design

The choice of nozzle diameters can optimize jet impact length and flow rate at the desired pressure. As standard documentation, the Alfa Laval GJ BB can be supplied with a "Declaration of Conformity" for material specifications.

### TRAX simulation tool

TRAX is a unique software that simulates how the Alfa Laval GJ BB performs in a specific tank or vessel. The simulation gives information on wetting intensity, pattern mesh width and cleaning jet velocity. This information is used to determine the best location of the tank cleaning device and the correct combination of flow, time, and pressure to implement.

A TRAX demo containing different cleaning simulations covering a variety of applications can be used as a reference and documentation for tank cleaning applications. The TRAX demo is free and available upon request.

### Wetting Intensity

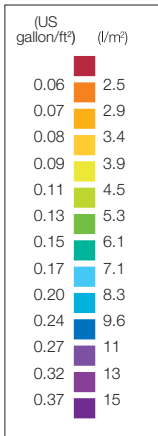

TD 523-208

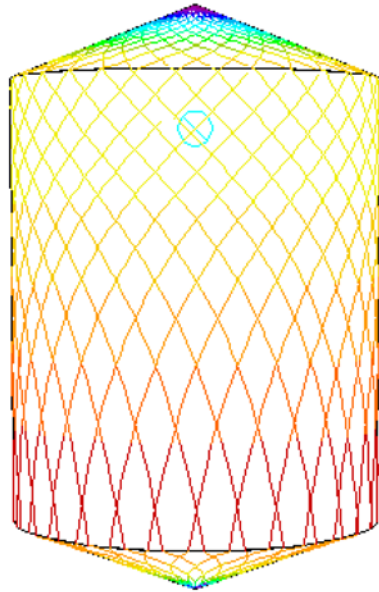

D2.5m, H4.1m, 2xØ2.03mm Time = 1 min.

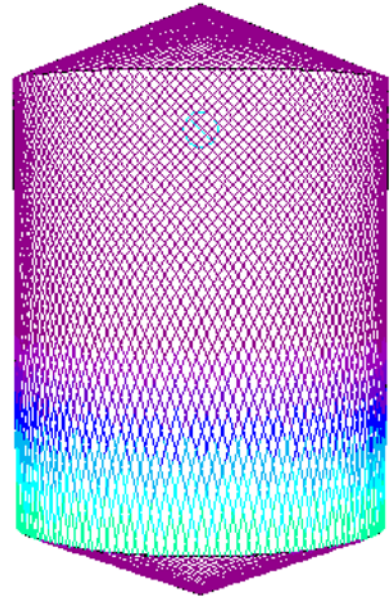

D2.5m, H4.1m, 2xØ2.03mm Time = 4 min.

Alfa Laval reserves the right to change specifications without prior notification.

---

**How to contact Alfa Laval**

Contact details for all countries  
are continually updated on our website.  
Please visit [www.alfalaval.com](http://www.alfalaval.com) to  
access the information direct.