



Alfa Laval GJ 10

First choice in fuel storage tank cleaning

Application

The Alfa Laval GJ 10 tank cleaning device fits through a 10.16 cm (4") opening and is capable of cleaning a 113.56 liter (30,000 gal) underground fuel storage tank with one insertion. This device blasts away contaminants and breaks up dirt and sludge in minutes. The Alfa Laval GJ 10 easily converts the contaminant-laden sludge into a solution which allows for complete liquid extraction and thorough tank cleaning. The device is part of the world-renowned Gamajet range of tank cleaning devices.

Working principle

The Gamajet range of high impact tank cleaning devices combine pressure and flow to create high impact cleaning jets. Cleaning occurs at the point at which the concentrated stream impacts the surface. It is this impact and the tangential force that radiates from that point which blasts contaminants from the surface, scouring the tank interior. In conjunction with this impact, the device is engineered to rotate in a precise, repeatable and reliable, 360° pattern. This full-coverage, global indexing pattern ensures the entire tank interior is cleaned, every time.



TECHNICAL DATA

Lubricant Food grade
 Max. throw length 10.5 m

Pressure

Working pressure 2.75 - 20 bar
 Recommended pressure 3.5 - 18.5 bar

Cleaning Pattern

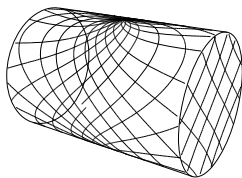

First Cycle

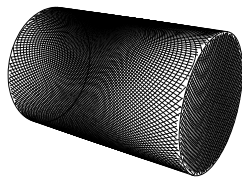

Full Pattern

The above drawings show the cleaning pattern achieved on a cylindrical horizontal vessel. The difference between the first cycle and the full pattern represents the number of additional cycles available to increase the density of the cleaning.

PHYSICAL DATA

Materials

1.4404 (316L), PPS, FKM (EPDM and FFKM available)

Temperature

Max. working temperature 95°C
 Max. ambient temperature 140°C

Weight

. 4.3 kg

Connections

Standard thread 1½" NPT, 1½" BSP

Caution

Avoid hydraulic shock, hard and abrasive particles in the cleaning liquid, as this can cause increased wear and/or damage of internal mechanisms. In general, a filter in the supply line is recommended. Do not use for gas evacuation or air dispersion. For steaming we refer to the manual.

Flow Rate

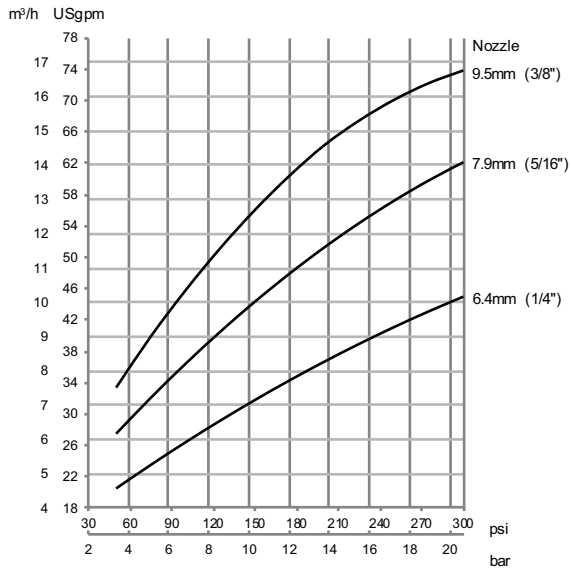

Inlet pressure

Impact Throw Length

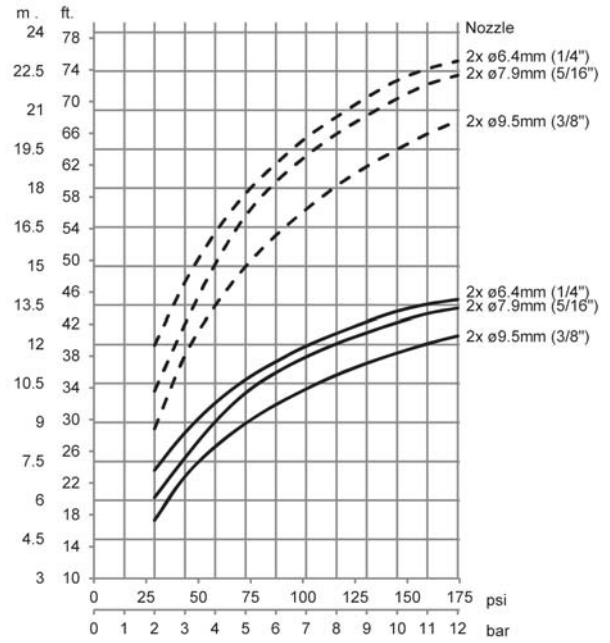

Inlet pressure

- - - Wetting, — Impact cleaning

Cleaning Time

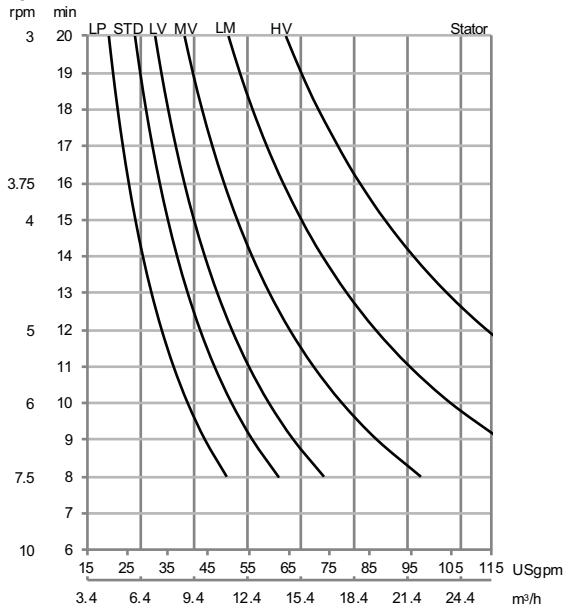

Dimensions

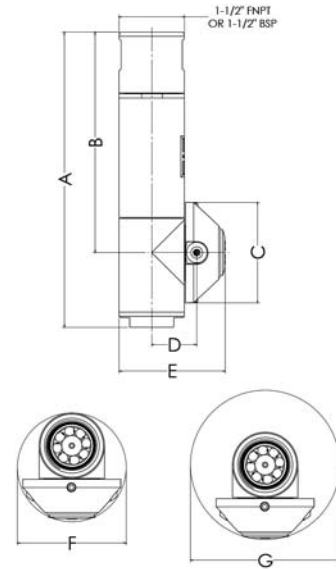

Dimensions

	A	B	C	D	E	F	G
mm	272	204	93	42	98	100	138
in	10.7	8	3.7	1.7	3.9	3.9	5.4

Standard Design

The choice of nozzle diameters can optimize jet impact length and flow rate at the desired pressure. As standard documentation, the Alfa Laval GJ 10 can be supplied with a "Declaration of Conformity" for material specifications.

TRAX simulation tool

TRAX is a unique software that simulates how the Alfa Laval GJ 10 performs in a specific tank or vessel. The simulation gives information on wetting intensity, pattern mesh width and cleaning jet velocity. This information is used to determine the best location of the tank cleaning device and the correct combination of flow, time, and pressure to implement.

A TRAX demo containing different cleaning simulations covering a variety of applications can be used as a reference and documentation for tank cleaning applications. The TRAX demo is free and available upon request.

Wetting Intensity

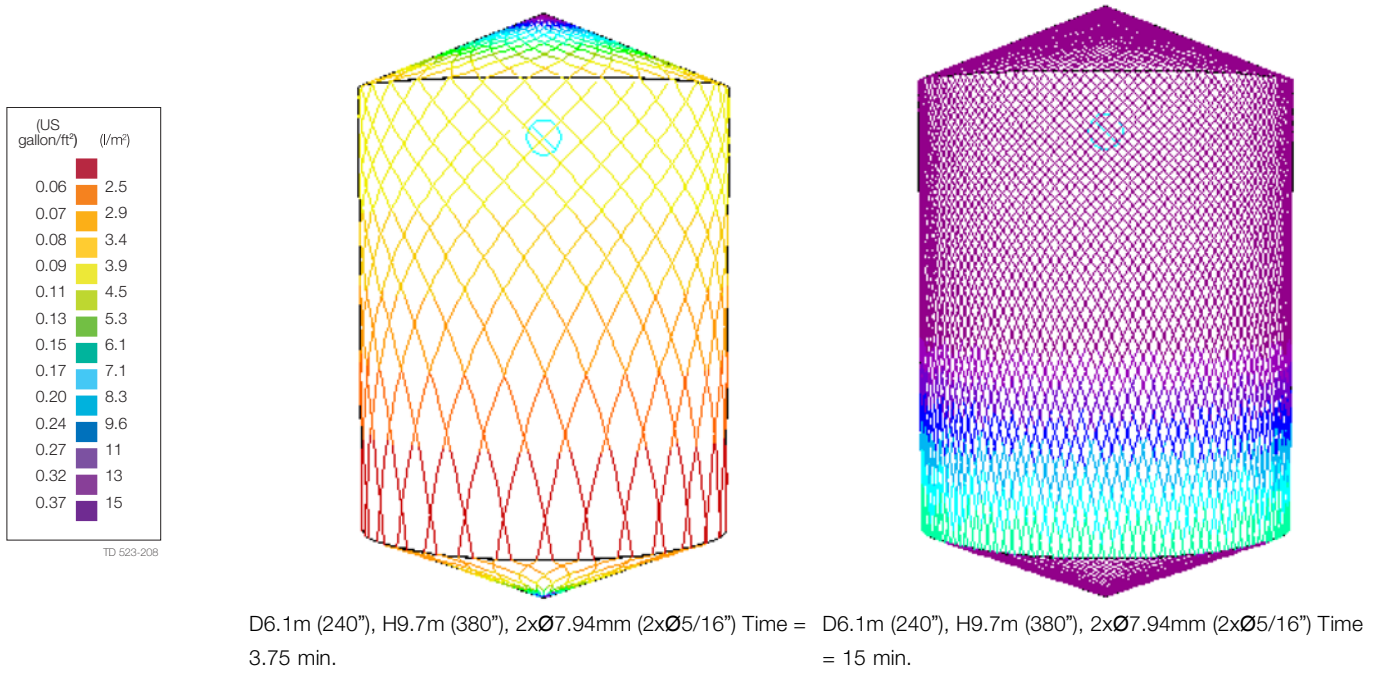

Alfa Laval reserves the right to change specifications without prior notification.

How to contact Alfa Laval

Contact details for all countries
are continually updated on our website.
Please visit www.alfalaval.com to
access the information direct.